

ZZ2L

Vertical Flow Configuration

Unit: inch

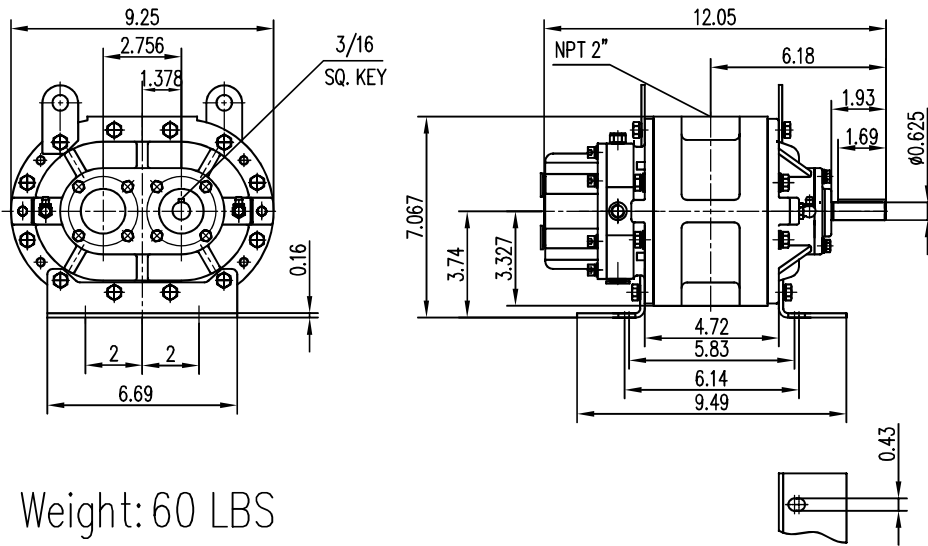

Weight: 60 LBS

ZZ2L

Horizontal Flow Configuration

Unit: inch

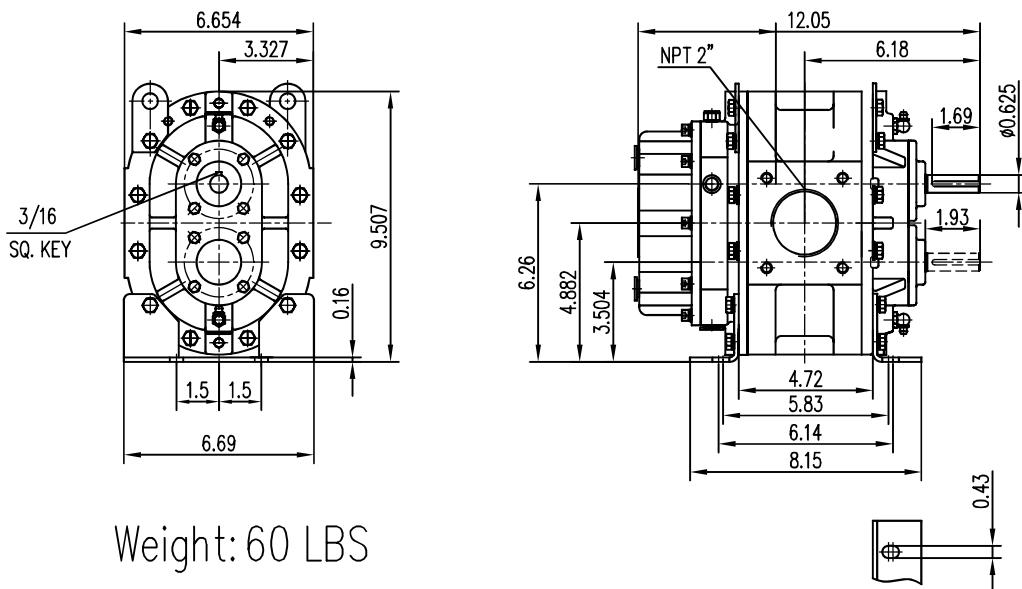

Weight: 60 LBS