

ZZ2M

Vertical Flow Configuration

Unit: inch

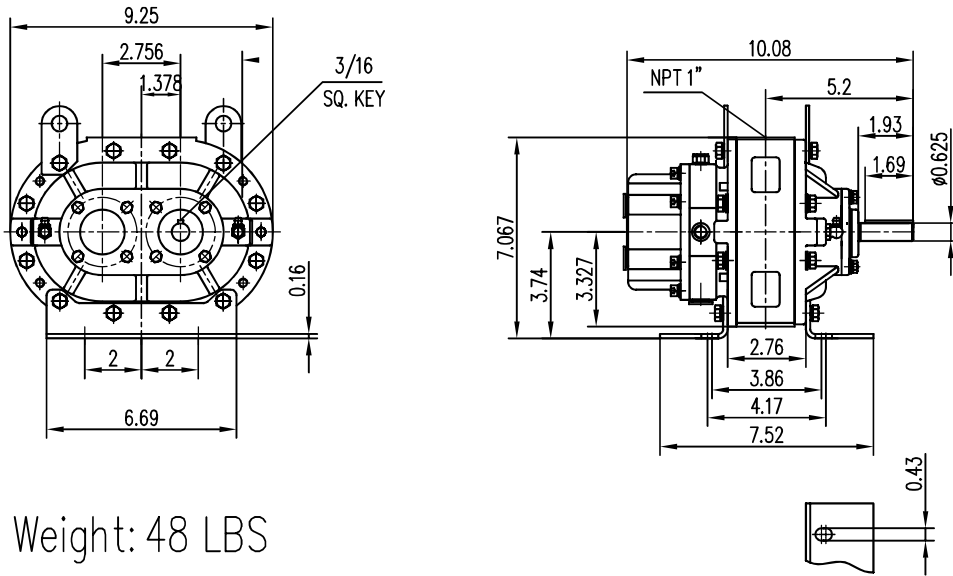

Weight: 48 LBS

ZZ2M

Horizontal Flow Configuration

Unit: inch

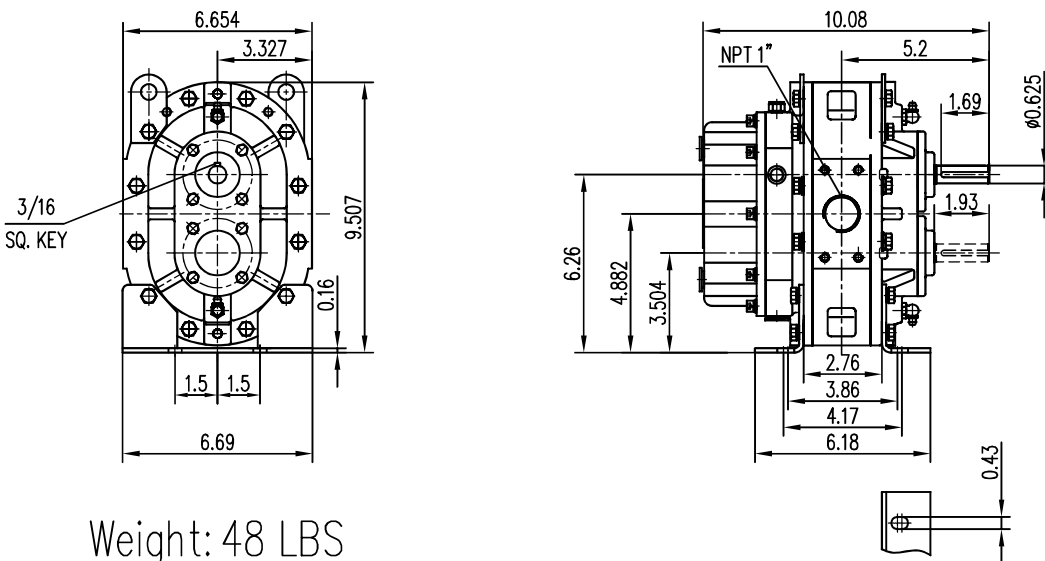

Weight: 48 LBS