

# ZZ7M

## Vertical Flow Configuration

Unit: inch

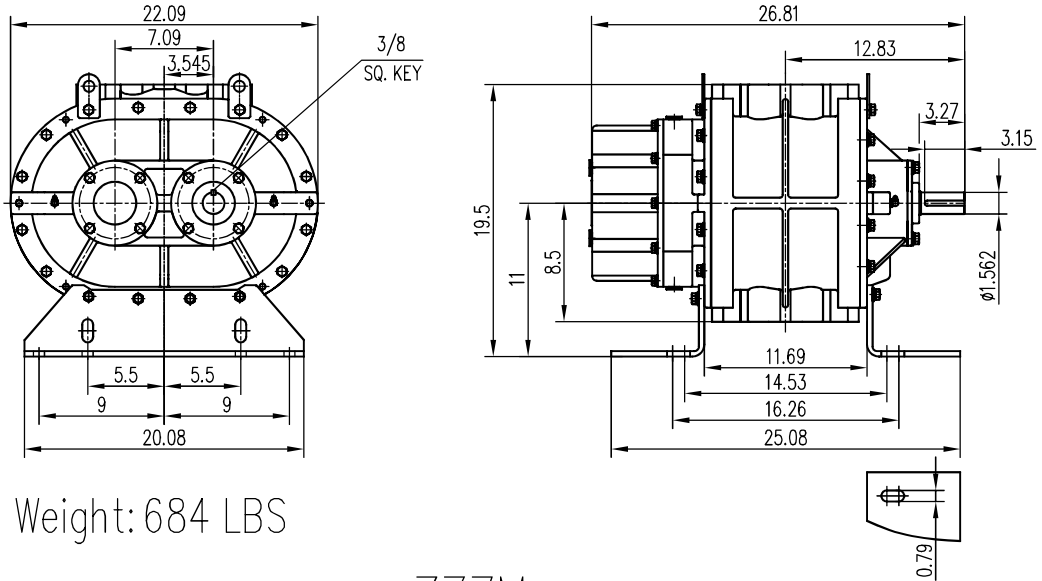

Weight: 684 LBS

# ZZ7M

## Horizontal Flow Configuration

Unit: inch

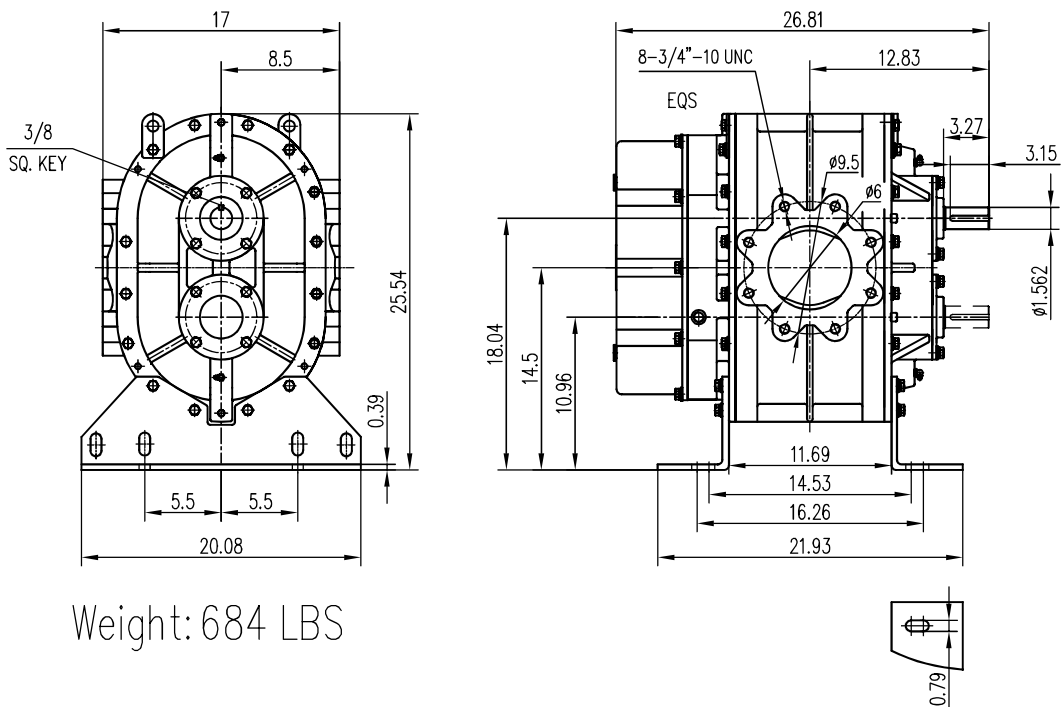

Weight: 684 LBS